



US009112179B2

(12) **United States Patent**
Park et al.

(10) **Patent No.:** **US 9,112,179 B2**
(45) **Date of Patent:** **Aug. 18, 2015**

(54) **ORGANIC LIGHT EMITTING DIODE DISPLAY**

(75) Inventors: **Soon-Ryong Park**, Yongin (KR);
Hee-Seong Jeong, Yongin (KR);
Woo-Suk Jung, Yongin (KR)

(73) Assignee: **Samsung Display Co., Ltd.**, Yongin-si (KR)

(*) Notice: Subject to any disclaimer, the term of this patent is extended or adjusted under 35 U.S.C. 154(b) by 902 days.

(21) Appl. No.: **12/786,304**

(22) Filed: **May 24, 2010**

(65) **Prior Publication Data**

US 2011/0024780 A1 Feb. 3, 2011

(30) **Foreign Application Priority Data**

Jul. 28, 2009 (KR) 10-2009-0069059

(51) **Int. Cl.**

H01L 51/52 (2006.01)

G02B 5/22 (2006.01)

(52) **U.S. Cl.**

CPC **H01L 51/5237** (2013.01); **G02B 5/223** (2013.01); **H01L 51/5253** (2013.01); **H01L 51/5281** (2013.01)

(58) **Field of Classification Search**

None
See application file for complete search history.

(56) **References Cited**

U.S. PATENT DOCUMENTS

4,802,873 A * 2/1989 Barrow et al. 445/6
7,456,570 B2 11/2008 Kawamura et al.
7,659,012 B2 2/2010 Kim et al.

7,923,923 B2 4/2011 Cho et al.
8,237,356 B2 8/2012 Cho et al.
2004/0076853 A1* 4/2004 Jarikov 428/690
2005/0058826 A1 3/2005 Decker et al.
2005/0087769 A1 4/2005 Yamazaki et al.
2005/0275342 A1 12/2005 Yanagawa
2007/0132378 A1 6/2007 Cok et al.
2008/0129189 A1* 6/2008 Cok 313/503
2009/0072733 A1* 3/2009 Funayama et al. 313/506

FOREIGN PATENT DOCUMENTS

JP 1986-096695 * 5/1986 H05B 33/04
JP 07-150136 6/1995
JP 07-272848 10/1995
JP 09-115664 5/1997
JP 2947106 B2 7/1999
JP 2003-151775 5/2003

(Continued)

OTHER PUBLICATIONS

Partial English translation of JP 1986-096695. Feb. 11, 2005.*

(Continued)

Primary Examiner — J. L. Yang

(74) *Attorney, Agent, or Firm* — Christie, Parker & Hale, LLP

(57) **ABSTRACT**

An organic light emitting diode includes a display substrate assembly including an organic light emitting element; an encapsulation substrate assembly disposed on the display substrate assembly with a space therebetween and sealed with the display substrate assembly in a vacuum-tight manner; and a filling agent filling the space between the display substrate assembly and the encapsulation substrate assembly. The filling agent is adapted to selectively absorb external light entering through the encapsulation substrate assembly and incident on the organic light emitting element as a function of wavelength in a wavelength band of the external light to control transmittance.

15 Claims, 4 Drawing Sheets

101

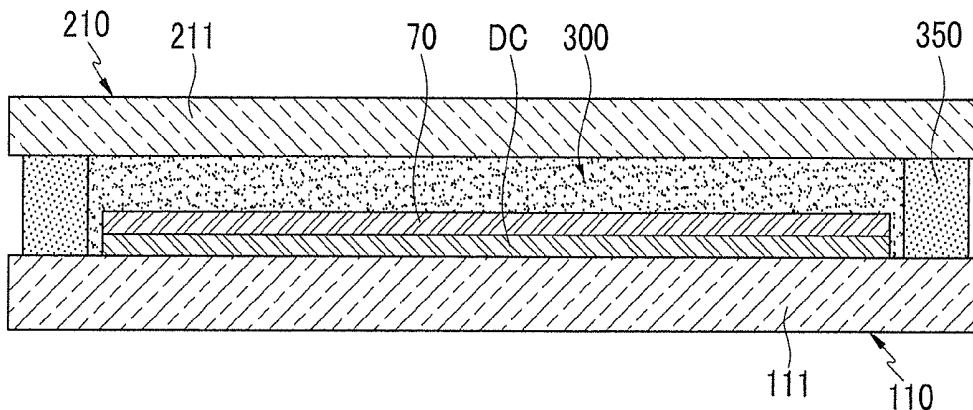

(56)

References Cited

FOREIGN PATENT DOCUMENTS

JP	2003-257622	9/2003	
JP	2004-241134	8/2004	
JP	2006-127815	5/2006	
JP	2006-172818	6/2006	
JP	2006-228519	8/2006	
JP	2006-252857	9/2006	
JP	2007-042367	2/2007	
JP	2008-016379	1/2008	
JP	2008-021480	1/2008	
JP	2008-59836 A	3/2008	
JP	2008-210788	9/2008	
JP	2008-235089	10/2008	
KR	10-0384291 B1	5/2003	
KR	10-0459175 B1	12/2004	
KR	10-0553758 B1	2/2006	
KR	10-2006-0031590	4/2006	
KR	10-0637179 B1	10/2006	
KR	10-2007-0071261	7/2007	
KR	10-0759665 B1	9/2007	
KR	10-0829753 B1	5/2008	
KR	10-2008-0087257	10/2008	
KR	10-2008-0090657	10/2008	
WO	WO 03/101155 A1	12/2003	
WO	WO 2004/095597 A2 *	11/2004 H01L 51/00

OTHER PUBLICATIONS

Machine English translation of JP 2008-059836 A. May 31, 2013.*
 Patent Abstracts of Japan for Publication 08-162275 dated Jun. 21, 1996, corresponding to Japanese Patent 2947106 dated Jul. 2, 1999 listed above, (1 page).
 Korean Patent Abstracts for Korean Publication 10-2002-0069319 dated Aug. 30, 2002, corresponding to Korean Patent 10-0384291 dated May 16, 2003, listed above, (1 page).
 Korean Patent Abstracts for Korean Publication 10-2003-0052049 dated Jun. 26, 2003, corresponding to Korean Patent 10-459175 dated Dec. 3, 2004, listed above, (1 page).
 Korean Patent Abstracts for Korean Publication 10-2005-0078763 dated Aug. 8, 2005, corresponding to Korean Patent 10-0553758 dated Feb. 20, 2006, listed above, (1 page).
 Korean Patent Abstracts for Korean Publication 10-2006-0034927 dated Apr. 26, 2006, corresponding to Korean Patent 10-0637179 dated Oct. 23, 2006, listed above, (1 page).
 Korean Patent Abstracts for Korean Publication 10-2007-0078502 dated Aug. 1, 2007, corresponding to Korean Patent 10-0759665 dated Sep. 17, 2007, listed above, (1 page).
 EPO Search Report dated Jan. 27, 2014, for corresponding European Patent application 10251340.5, (8 pages).
Electro-lite is UV Light Curing Technology, Jan. 1, 2005, pp. 1-2, XP 055097135, URL: <http://www.allsealsinc.com/pdf/Electro-lite-Compounds.pdf>.

* cited by examiner

FIG. 1

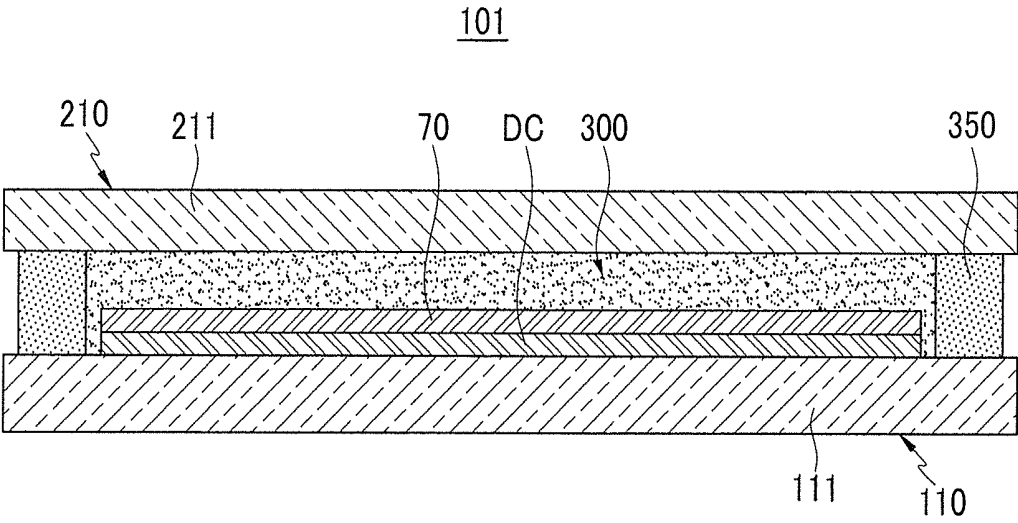

FIG. 2

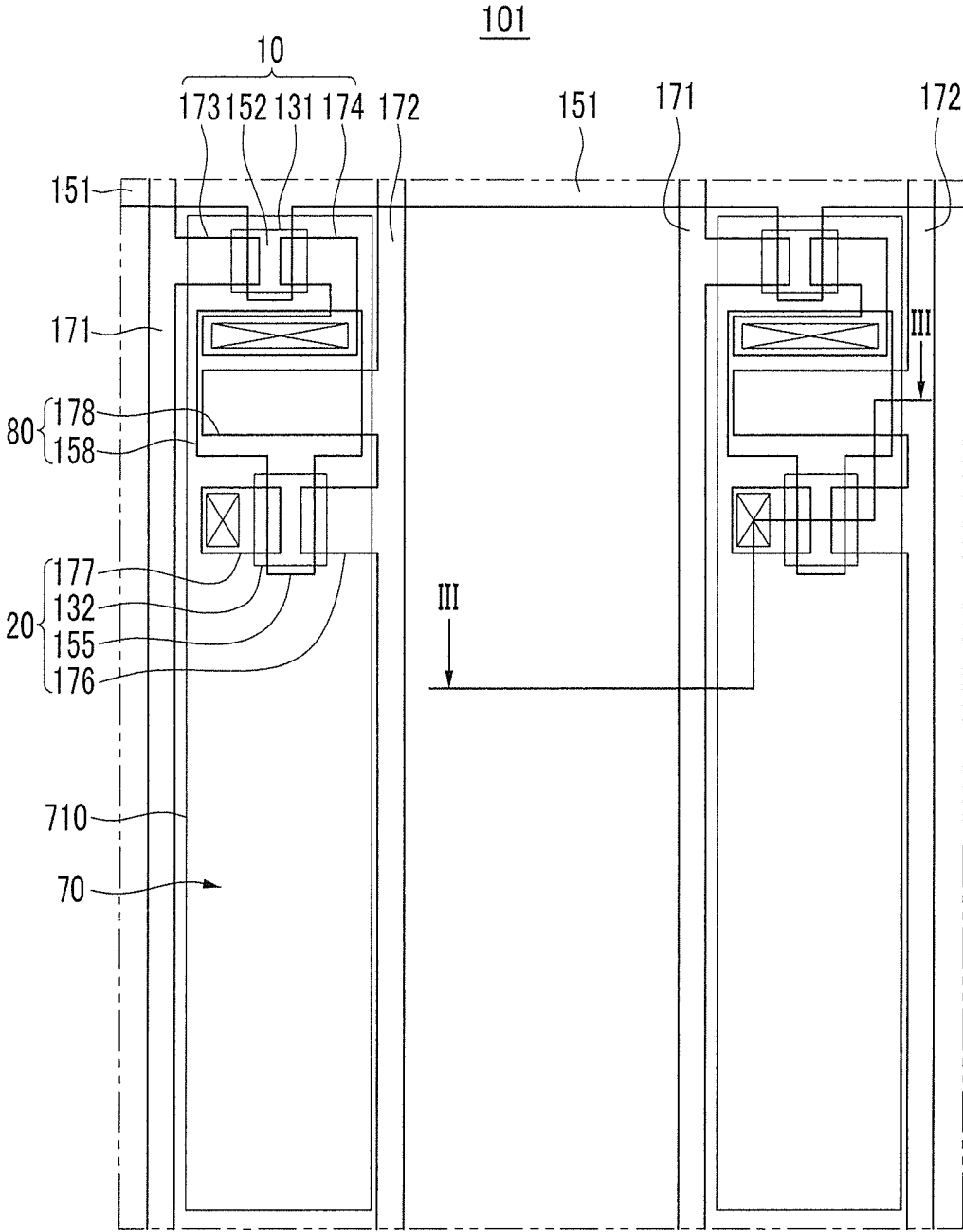

FIG. 3

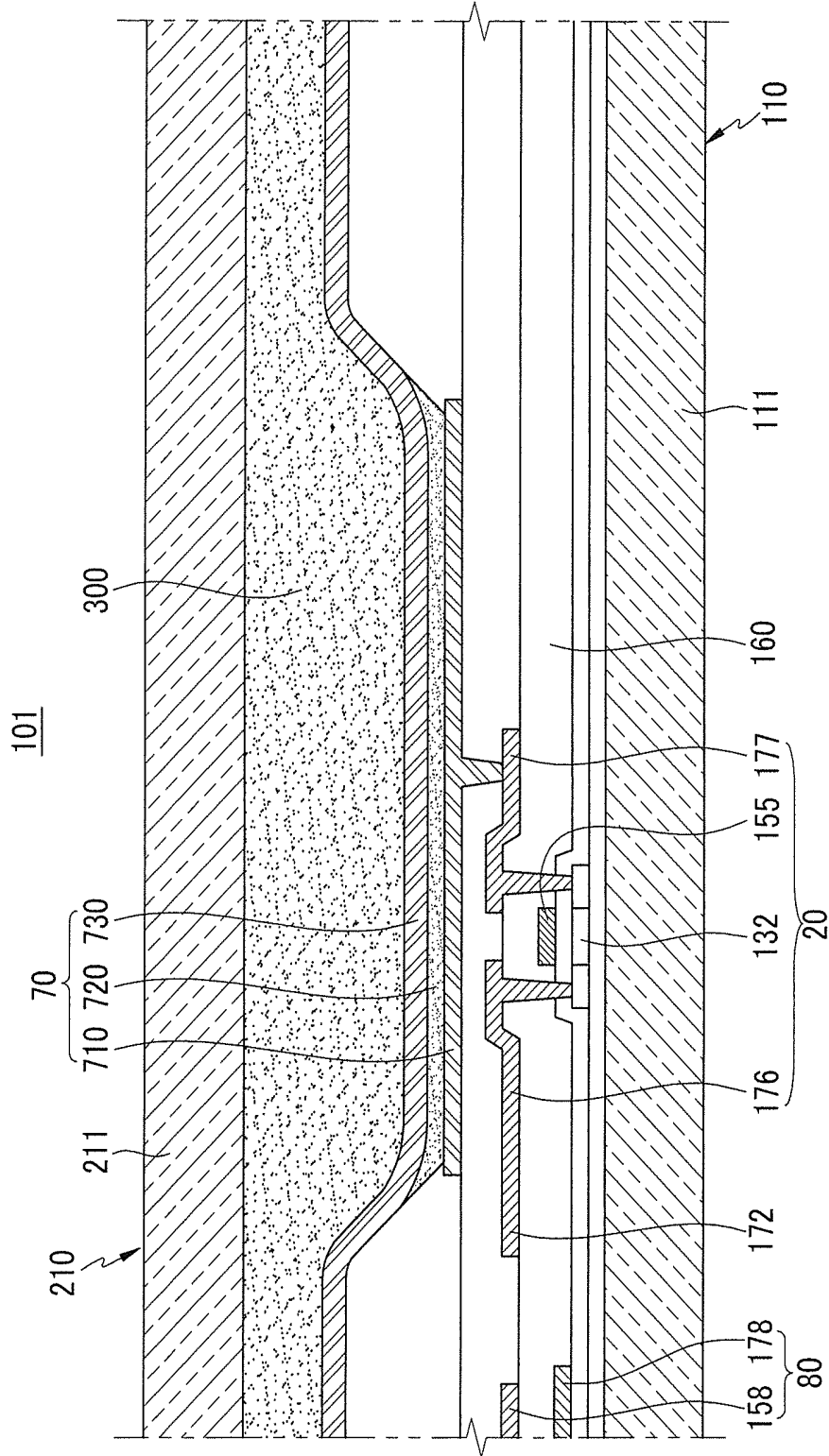
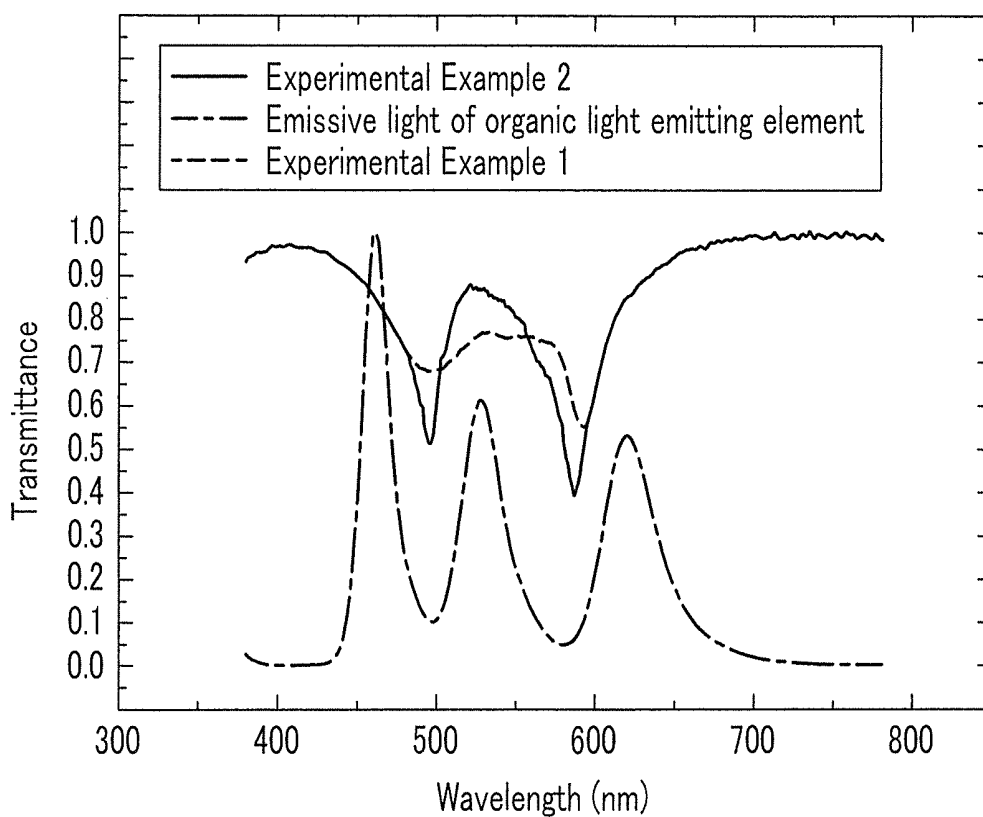

FIG.4



1

**ORGANIC LIGHT EMITTING DIODE
DISPLAY****CROSS-REFERENCE TO RELATED
APPLICATION**

This application claims priority to and the benefit of Korean Patent Application No. 10-2009-0069059, filed in the Korean Intellectual Property Office, on Jul. 28, 2009, the entire content of which is incorporated herein by reference.

BACKGROUND**1. Field**

The following description relates generally to an organic light emitting diode (OLED) display. More particularly, the following description relates generally to an OLED display of which impact durability and display characteristics are improved.

2. Description of the Related Art

An organic light emitting diode (OLED) display is an emissive or self-luminance display, and differs from a liquid crystal display (LCD) in that it does not require a separate light source so that it can be made to be relatively thin and light in weight. Furthermore, as the OLED display has characteristics such as relatively low power consumption, high luminance, and short response time, it has been spotlighted as a next generation display device.

In the OLED display, the hole injection electrodes or the electron injection electrodes of the OLED display, and other various metal wires thereof, reflect light that is incident thereupon from the outside. When the OLED display is used in a bright location, the black color expression and the contrast thereof may be poor due to the reflection of external light.

In order to reduce the reflection of external light, a polarizing plate and a phase delay plate may be utilized in an OLED display for suppressing reflection of the external light. However, a conventional method that suppresses reflection of external light through the polarizing plate and the phase delay plate has a problem in that a large amount of light generated from an organic emission layer can also be lost when the light is emitted to the outside through the polarizing plate and the phase delay plate.

The above information disclosed in this Background section is only for enhancement of understanding of the background of the described technology and therefore it may contain information that does not form the prior art that is already known in this country to a person of ordinary skill in the art.

SUMMARY

An aspect of an embodiment of the present invention is directed toward an OLED display having improved impact durability and ability to suppress reflection of external light to

2

thereby improve visibility and reduce (minimize) a loss of light emitted to the outside from an organic light emitting element in the OLED display.

An organic light emitting diode (OLED) display according to an exemplary embodiment includes: a display substrate assembly including an organic light emitting element; an encapsulation substrate assembly on the display substrate assembly with a space therebetween, the encapsulation substrate assembly being sealed with the display substrate assembly; and a filling agent filling the space between the display substrate assembly and the encapsulation substrate assembly. Here, the filling agent is adapted to selectively absorb external light entering through the encapsulation substrate assembly and incident on the organic light emitting element as a function of wavelength in a wavelength band of the external light to control transmittance.

The filling agent may be adapted to selectively absorb the external light having wavelengths in a wavelength band of 430 nm to 670 nm.

The transmittance of the external light with respect to the filling agent may be higher in a wavelength band of 520 nm to 560 nm than in wavelength bands of 480 nm to 510 nm and of 580 nm to 610 nm.

The transmittance of the external light with respect to the filling agent in a wavelength band of 460 nm to 620 nm may satisfy a W shape like a quartic function having two minimums and one maximum.

The two minimums may be respectively in the wavelength band of 480 nm to 510 nm and the wavelength band of 580 nm to 610 nm, and the maximum may be in the wavelength band of 520 nm to 560 nm.

Wavelengths of more than 80% of emissive light of the organic light emitting element may be in one or more specific wavelength bands, and the one or more specific wavelength bands may not be overlapped with the wavelength bands of 480 nm to 510 nm and of 580 nm to 610 nm.

The wavelengths of more than 80% of the emissive light of the organic light emitting element may be in the wavelength bands of 450 nm to 480 nm, of 510 nm to 560 nm, and of 600 nm to 650 nm.

The filling agent may include a resin containing a light absorbing material.

The transmittance of the external light by the filling agent may be controlled according to the type and content of the light absorbing material.

The resin may include at least one of polycarbonate, polyether sulfone (PES), polymethyl methacrylate, (PMMA), polyethylene terephthalate, or triacetate cellulose.

The light absorbing material may include at least one of carbon black, a polyene-based pigment, an azo-based pigment, an azomethine-based pigment, a diimmonium-based pigment, a phthalocyanine-based pigment, a quinine-based pigment, an indigo-based pigment, a thioindigo-based pigment, a dioxadin-based pigment, a quinacridone-based pigment, an isoindolinone-based pigment, a metal oxide, a metal complex, or aromatic hydrocarbons.

The polyene-based pigment may include a compound represented by at least one of Formula 1 or Formula 2:

Formula 1

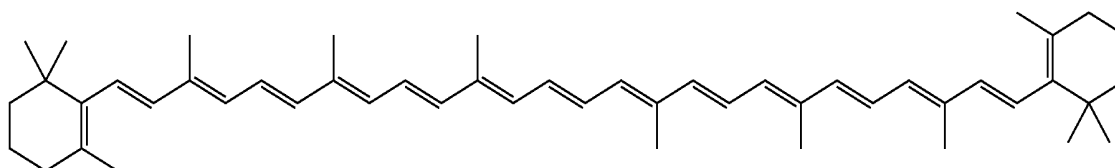

3

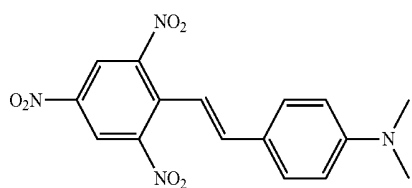

The azo-based pigment may include a compound represented by Formula 3:

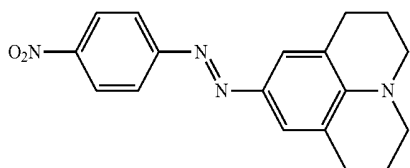

Formula 3 15

20

The quinacridone-based pigment may include a compound represented by at least one of Formula 4 or Formula 5:

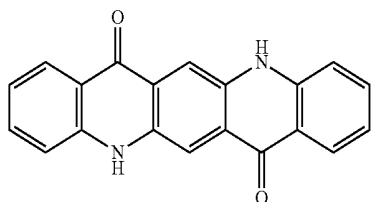

Formula 4

25

30

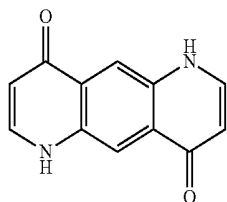

Formula 5 35

40

The quinine-based pigment may include a compound represented by at least one of Formula 6, Formula 7, or Formula 8:

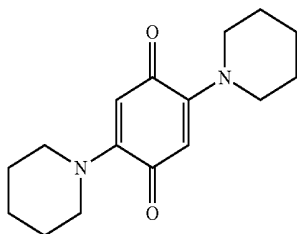

Formula 6

50

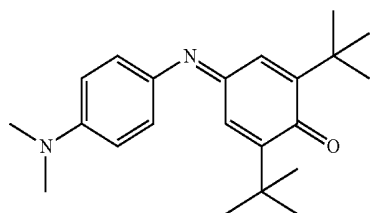

Formula 7

60

65

4

-continued

Formula 2

-continued

Formula 8

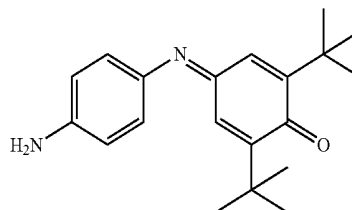

The indigo-based pigment may include a compound represented by at least one of Formula 9, Formula 10, or Formula 11:

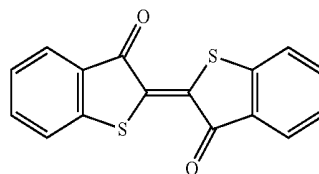

Formula 9

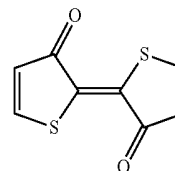

Formula 10

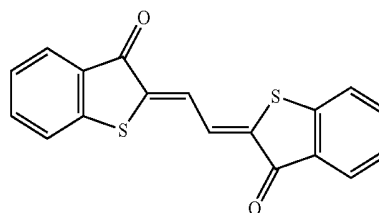

Formula 11

The aromatic hydrocarbons may include a compound represented by at least one of Formula 12, Formula 13, Formula 14, Formula 15, Formula 16, Formula 17, or Formula 18:

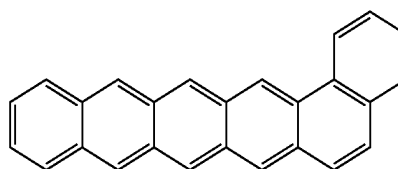

Formula 12

5

-continued

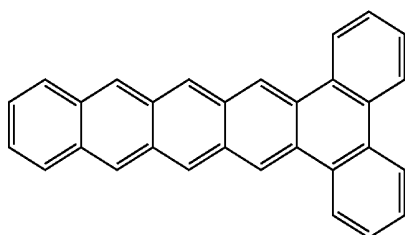

Formula 13

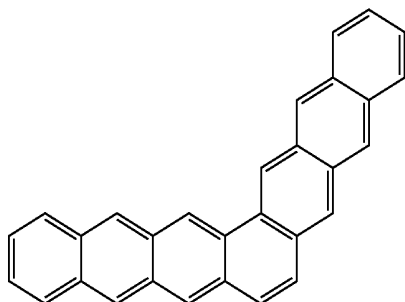

Formula 14

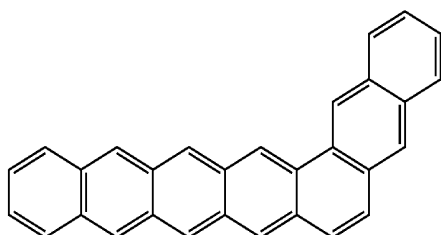

Formula 15

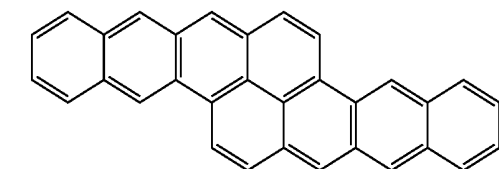

Formula 16

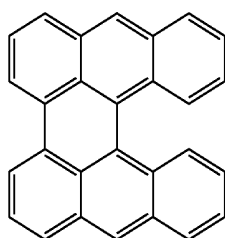

Formula 17

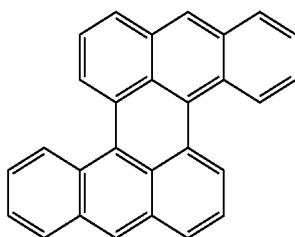

Formula 18

According to the present invention, the OLED display improves impact durability and at the same time improves visibility by suppressing reflection of external light, and a loss of light emitted to the outside from the organic light emitting element can be reduced (minimized).

6

BRIEF DESCRIPTION OF THE DRAWINGS

FIG. 1 is a cross-sectional view of an organic light emitting diode (OLED) display according to an exemplary embodiment.

FIG. 2 is an enlarged layout view of an internal structure of the OLED display of FIG. 1.

FIG. 3 is a cross-sectional view of FIG. 2, taken along the line III-III.

FIG. 4 is a graph illustrating a transmittance distribution for each wavelength band of Experimental Example 1 and Experimental Example 2 according to embodiments of the present invention.

DETAILED DESCRIPTION

In the following detailed description, only certain exemplary embodiments of the present invention are shown and described, by way of illustration. As those skilled in the art would recognize, the invention may be embodied in many different forms and should not be construed as being limited to the embodiments set forth herein. Also, in the context of the present application, when a first element is referred to as being "on" a second element, it can be directly on the second element or be indirectly on the second element with one or more intervening elements interposed therebetween. Like reference numerals designate like elements throughout the specification.

In addition, in FIG. 2 and FIG. 3, an organic light emitting diode (OLED) display is illustrated as an active matrix (AM)-type OLED display in a 2Tr-1Cap structure in which two TFTs T1 and T2 and one storage capacitor C1 are formed in one pixel, but the present invention is not limited thereto. Therefore, the OLED display according to the embodiments of the present invention can have various suitable structures. For example, three or more TFTs and two or more capacitors can be provided in one pixel of the OLED display, and separate wires can be further provided in the OLED display. Here, a pixel is a minimum unit for displaying an image, and the OLED display displays an image by using a plurality of pixels.

Hereinafter, an exemplary embodiment will be described with reference to FIGS. 1, 2, and 3.

As shown in FIG. 1, an organic light emitting diode (OLED) display 101 according to an exemplary embodiment includes a display substrate assembly 110, an encapsulation substrate assembly 210, a sealant 350, and a filling agent 300.

The display substrate assembly 110 includes a first substrate 111, a driving circuit (DC), and an organic light emitting element 70. The driving circuit DC and the organic light emitting element 70 are formed on the first substrate 111.

The first substrate 111 may be formed of an insulating substrate made of glass, quartz, ceramic, and/or plastic. However, the exemplary embodiment is not limited thereto, and the first substrate 111 may be formed of a metallic substrate made of stainless steel.

The driving circuit DC includes thin film transistors 10 and 20 (shown in FIG. 5), and drives the organic light emitting element 70. The organic light emitting element 70 emits light according to a driving signal transmitted from the driving circuit DC to display images.

Detailed structures of the organic light emitting element 70 and the driving circuit DC are shown in FIG. 2 and FIG. 3, but the exemplary embodiment is not limited to the structures shown in FIG. 2 and FIG. 3. The OLED 70 and the driving circuit may be suitably modified.

Also, in the exemplary embodiment, wavelengths of more than 80% of light emitted from the organic light emitting element **70** are in wavelength ranges (bands) of 450 nm to 480 nm, of 510 nm to 560 nm, and of 600 nm to 650 nm. That is, the organic light emitting element **70** mainly emits white light which is a mixture of light having wavelengths in the three wavelength ranges (bands).

The encapsulation substrate assembly **210** is disposed at a distance from the display plate **110**, and the encapsulation substrate assembly **210** and the display substrate assembly **110** are sealed in a vacuum-tight manner. As described, the encapsulation substrate assembly **210** sealed with the display substrate assembly **110** covers the organic light emitting element **70** and the driving circuit DC of the display substrate assembly **110** for protection. The encapsulation substrate assembly **210** includes a second substrate **211** made of a transparent material such as glass and plastic.

The filling agent **300** is disposed between the display substrate assembly **110** and the encapsulation substrate assembly **210** to fill a space formed between the display substrate assembly **110** and the encapsulation substrate assembly **210**. As described, the filling agent **300** improves mechanical strength by filling the space between the display substrate assembly **110** and the encapsulation substrate assembly **210**. That is, the inside of the OLED display **101** is filled with the filling agent **300** so that durability to external impact can be improved.

In addition, the filling agent **300** selectively absorbs external light incident upon the organic light emitting element **70** of the display substrate assembly **110** that has entered from the outside through the encapsulation substrate assembly **210** depending on (or as a function) the wavelength in the wavelength range (band) of the external light to control transmittance.

In the exemplary embodiment, the filling agent **300** absorbs external light in a wavelength range of 430 nm to 670 nm. In addition, the filling agent **300** absorbs a different amount of external light depending on (or as a function of) the wavelength in the wavelength range of 430 nm to 670 nm. That is, the filling agent **300** selectively absorbs the external light so that transmittance of the external light with respect to the filling agent **300** is changed depending of the wavelength of the wavelength range (band).

In further detail, a wavelength band-specific transmittance of the external light with respect to the filling agent **300** is higher in the wavelength range of 520 nm to 560 nm than in the wavelength range of 480 nm to 510 nm and the wavelength range of 580 nm to 680 nm.

That is, a graph illustrating the wavelength band-specific transmittance of the external light with respect to the filling agent **300** has a W-shape like a quartic function having two minimums and one maximum within a wavelength range of 460 nm to 620 nm. Here, the two minimums are respectively located in a wavelength range of 480 nm to 510 nm and a wavelength range of 580 nm to 610 nm, and the maximum is located in a wavelength range of 520 nm to 560 nm. As described, the filling agent **300** absorbs external light in a specific wavelength range (band) among external light that has entered through the encapsulation substrate assembly **210** and is incident upon the organic light emitting element **70** of the display substrate assembly **110** so as to suppress reflection of external light. The filling agent **300** absorbs some external light included in the wavelength range of 430 nm to 670 nm, and intensively absorbs external light included in the wavelength range of 580 nm to 680 nm.

Emissive light of the organic light emitting element **70** is mainly included in wavelength ranges of 450 nm to 480 nm,

510 nm to 560 nm, and 600 nm to 650 nm. Here, as described above, the wavelengths of more than 80% of the emissive light of the organic light emitting element **70** are included in one or more specific wavelength bands (e.g., the above three described specific wavelength ranges (bands)), and the one or more specific wavelength bands (to which the wavelengths of most of the emissive light are included in) are not overlapped with the wavelength bands where the transmittance of the external light with respect to the filling agent **300** is relatively low, which are in the wavelength ranges (bands) of 480 nm to 510 nm and of 580 nm to 610 nm. Therefore, compared to the external light, a loss of the emissive light of the organic light emitting element **70** when passing through the filling agent **300** is relatively low.

As described, the transmittance of the filling agent **300** is controlled to reduce or minimize absorption of emissive light of the organic light emitting element **70** and increase or maximize absorption of external light. That is, the filling agent **300** suppresses reflection of external light by absorbing a great amount of external light, but a relatively small amount of emissive light of the organic light emitting element **70**, passing through the filling agent **300**, is lost. Accordingly, the filling agent **300** can reduce or minimize a loss of light emitted outside from the organic light emitting element **70** while improving visibility by suppressing reflection of external light.

In addition, the filling agent **300** includes a resin containing a light absorbing material. The external light transmittance by the filling agent **300** can be controlled according to the type and content of the light absorbing materials that are utilized.

Here, in one embodiment, the resin includes polycarbonate, polyether sulfone (PES), polymethyl methacrylate, (PMMA), polyethylene terephthalate, and/or triacetate cellulose.

The light absorbing material includes carbon black, a polyene-based pigment, an azo-based pigment, an azomethine-based pigment, a diimmonium-based pigment, a phthalocyanine-based pigment, a quinine-based pigment, an indigo-based pigment, a thioindigo-based pigment, a dioxadin-based pigment, a quinacridone-based pigment, an isoindolinone-based pigment, a metal oxide, a metal complex, and/or aromatic hydrocarbons.

The light absorbing material absorbs light in a specific wavelength band according to the type thereof. Therefore, the filling agent **300** may have transmittance that is selective to a wavelength band of external light according to the light absorbing material included therein. That is, light transmittance can be intensively controlled in a specific wavelength band in consideration of external light of which reflection is to be suppressed and a main wavelength band of the emissive light of the organic light emitting element **70**. In this case, the light absorbing material can be made of a combination of various suitable materials.

Some of light absorbing materials that can be included in the filling agent **300** will be exemplarily described in further detail. The filling agent **300** can selectively control a transmittance of external light in a specific wavelength band by including one or two or more of light absorbing materials to be described hereinafter.

In one embodiment, the polyene-based pigment includes a compound represented by Formula 1 and/or Formula 2.

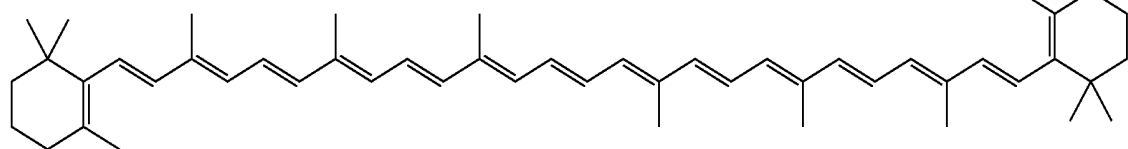

Formula 1

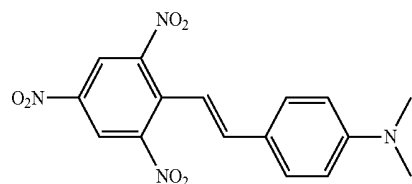

Formula 2

Here, the compound of Formula 1 is called dodecaprenobeta-carotene, and enables absorbing of light having a wavelength range of about 480 nm to about 530 nm. The compound of Formula 2 is called a trans-stilbene, and enables absorbing of light having a wavelength of about 525 nm.

In one embodiment, the azo-based pigment includes a compound represented by Formula 3.

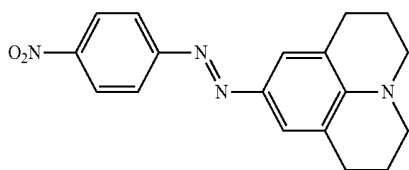

Formula 3

Here, the compound of Formula 3 enables absorbing of light having a wavelength of about 518 nm.

In one embodiment, the quinacridone-based pigment includes a compound represented by Formula 4 and/or Formula 5.

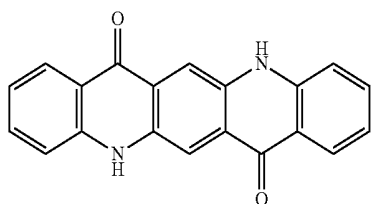

Formula 4

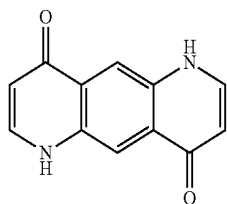

Formula 5

Here, the compound of Formula 4 may absorb light having a wavelength of about 523 nm, and the compound of Formula 5 may absorb light having a wavelength of about 528 nm.

In one embodiment, the quinone-based pigment includes a compound represented by Formula 6, Formula 7, and/or Formula 8.

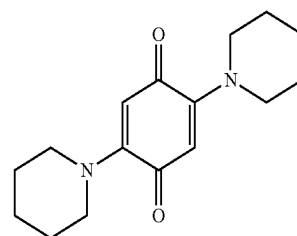

Formula 6

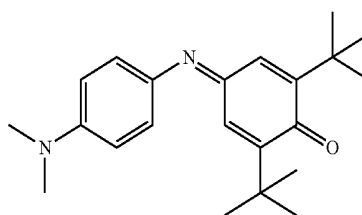

Formula 7

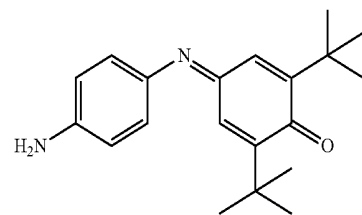

Formula 8

Here, the compound of Formula 6 may absorb light having a wavelength of about 528 nm, the compound of Formula 7 may absorb light having a wavelength of about 549 nm, and the compound of Formula 8 may absorb light having a wavelength of about 508 nm.

In one embodiment, the indigo-based pigment includes a compound represented by Formula 9, Formula 10, and/or Formula 11.

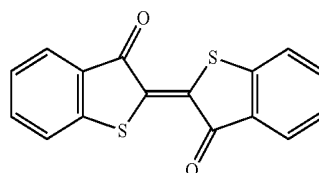

Formula 9

11
-continued

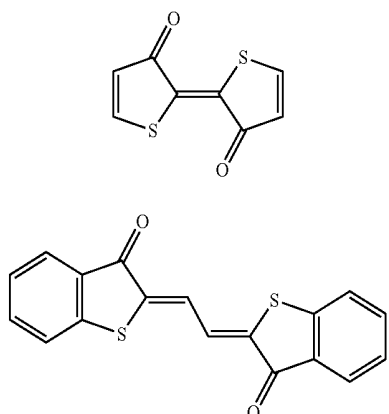

Here, the compound of Formula 9 may absorb light having a wavelength of about 546 nm, the compound of Formula 10 may absorb light having a wavelength of about 505 nm, and the compound of Formula 11 may absorb light having a wavelength of about 534 nm.

In one embodiment, the aromatic hydrocarbons include a compound represented by Formula 12, Formula 13, Formula 14, Formula 15, Formula 16, Formula 17, and/or Formula 18.

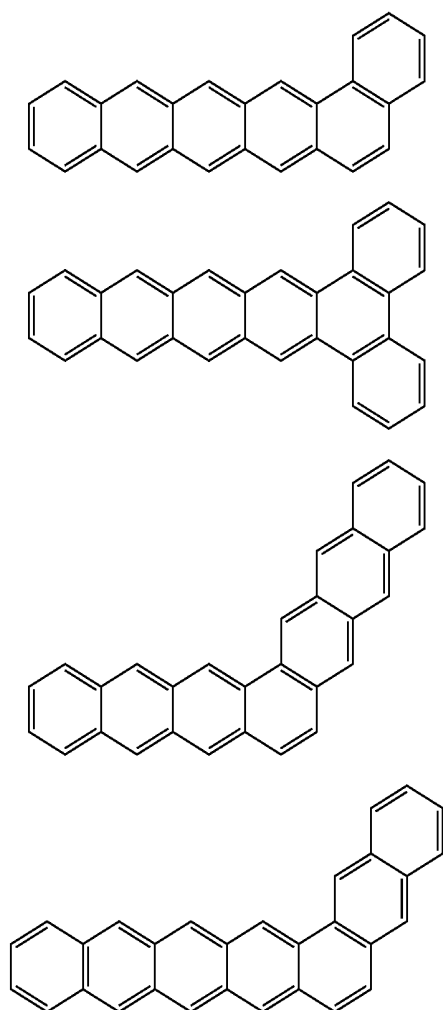

12
-continued

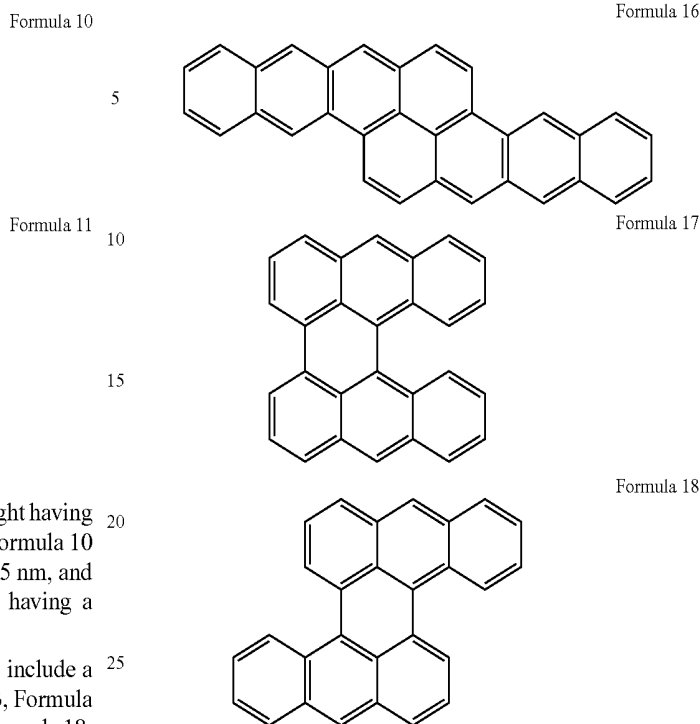

Here, the compound of Formula 12 may absorb light having a wavelength of about 523 nm, and the compound of Formula 13 may absorb light having a wavelength of about 512 nm. The compound of Formula 14 may absorb light having a wavelength of about 510 nm, and the compound of Formula 15 may absorb light having a wavelength of about 519 nm. The compound of Formula 16 may absorb light having a wavelength of about 534 nm, the compound of Formula 17 may absorb light having a wavelength of about 523 nm, and the compound of Formula 18 may absorb light having a wavelength of about 521 nm.

The sealant **350** is disposed between edges or edge portions of the display substrate assembly **110** and the encapsulation substrate assembly **210** to seal them in a vacuum-tight manner. That is, the display substrate assembly **110** and the encapsulation substrate assembly **210** are sealed in a vacuum-tight manner by the sealant **350**.

With the above-described configuration, the OLED display **101** can improve impact durability and at the same time improves visibility by suppressing reflection of external light, and loss of light emitted to the outside from the organic light emitting element **70** can be reduced or minimized. Therefore, use efficiency of overall light in the OLED display **101** is increased so that luminance can be improved.

In addition, the OLED display **101** can reduce power consumption and have an increased life-span.

Hereinafter, an internal structure of the OLED display **101** will be described in further detail with reference to FIG. 2 and FIG. 3. FIG. 2 is a layout view of a pixel structure, focusing on the display substrate assembly **110**, and FIG. 3 is a cross-sectional view of the display substrate assembly **110** and the encapsulation substrate assembly **210** of FIG. 2, taken along the line III-III.

As shown in FIG. 2 and FIG. 3, the display substrate assembly **110** includes a switching thin film transistor **10**, a driving thin film transistor **20**, a capacitor **80**, and an OLED **70**, which are formed at each pixel. Here, a configuration including the switching thin film transistor **10**, the driving

thin film transistor **20**, and the capacitor **80** is referred to as a driving circuit DC. In addition, the display substrate assembly **110** further includes gate lines **151** arranged to extend in a first direction, and data lines **171** and common power lines **172** that extend in a second direction crossing the first direction of the gate lines **151** in an insulated manner. Here, a pixel is defined by taking a gate line **151**, a data line **171**, and a common power line **172** as boundaries of the pixel, but the present invention is not limited thereto.

The organic light emitting element **70** includes a pixel electrode **710**, an organic emission layer **720** formed on the pixel electrode **710**, and a common electrode **730** formed on the organic emission layer **730**. The pixel electrode **710** functions as a positive (+) electrode that is utilized as a hole injection electrode, and the common electrode **730** functions as a negative (-) electrode that is utilized as an electron injection electrode. However, the present invention is not limited thereto, and depending upon the way of driving the OLED display **100**, it is possible that the pixel electrode **710** functions as the negative electrode and the common electrode **730** functions as the positive electrode. Holes and electrons from the pixel electrode **710** and the common electrode **730** are injected into the organic emission layer **720**. When excitons generated from combinations of electrons and holes shift from an excited state to a ground state, light emission occurs.

In the OLED display **101** according to an exemplary embodiment, the organic light emitting element **70** emits light toward a direction of the encapsulation substrate assembly **210**. That is, the organic light emitting element **70** is formed as a front emission type. For light emission of the organic light emitting element **70** toward the encapsulation substrate assembly **210** direction, the pixel electrode **710** may be formed as a reflective electrode and the common electrode **730** may be formed as a transparent or semi-transparent electrode.

The capacitor **80** includes a pair of capacitive plates **158** and **178**, interposing an interlayer insulating layer **160** therebetween. Here, the interlayer insulating layer **160** functions as a dielectric material. Capacitance is determined according to charges charged at the capacitor **80** and a voltage between the capacitive plates **158** and **178**.

The switching thin film transistor **10** includes a switching semiconductor layer **131**, a switching gate electrode **152**, a switching source electrode **173**, and a switching drain electrode **174**. The driving thin film transistor **20** includes a driving semiconductor layer **132**, a driving gate electrode **155**, a driving source electrode **176**, and a driving drain electrode **177**.

The switching thin film transistor **10** is used as a switch for selecting a pixel to emit light. The switching gate electrode **152** is connected to a gate line **151**. The switching source electrode **173** is connected to a data line **171**. The switching drain electrode **174** is disposed at a distance from the switching source electrode **173** and is connected to one of the capacitive plates, for example, the capacitive plate **158**.

The driving thin film transistor **20** applies a driving voltage to a pixel electrode **710** to excite an organic emission layer **720** of an organic light emitting element **70** in the selected pixel. The driving gate electrode **155** is connected to the capacitive plate **158** connected to the switching drain electrode **174**. The driving source electrode **176** and the other capacitive plate **178** are respectively connected to a common power line **172**. The driving drain electrode **177** is connected to the pixel electrode **710** of the organic light emitting element **70** through a contact hole.

With the above structure, the switching thin film transistor **10** is operated by the gate voltage applied to the gate line **161**,

and transmits the data voltage applied to the data line **171** to the driving thin film transistor **20**. The voltage with a value corresponding to a difference between the common voltage applied to the driving thin film transistor **20** from the common power line **172** and the data voltage transmitted from the switching thin film transistor **10** is stored at the capacitor **80**, and the current corresponding to the voltage stored at the capacitor **80** flows to the organic light emitting element **70** through the driving thin film transistor **20** to thereby excite the OLED **70** to emit light.

As shown in FIG. 3, the encapsulation substrate assembly **210** is disposed on the organic light emitting element **70** for protecting the encapsulation substrate assembly **210**. In addition, the filling agent **300** is filled between the display substrate assembly **110** and the encapsulation substrate assembly **210**.

Hereinafter, referring to FIG. 4, an effect of embodiments of the present invention will be described in further detail through Experimental Example 1 and Experimental Example 2. Experimental Example 1 and Experimental Example 2 were performed with different types and contents of a light absorbing material included in the filling agent **300**.

As shown in FIG. 4, the Experimental Example 1 and Experimental Example 2 both have W-type graphs for wavelength band-specific transmittance of external light through the filling agent. In addition, the band-specific transmittance of external light through the filling agent is higher in a range other than the ranges of 480 nm to 510 nm and 580 nm to 680 nm.

In addition, as shown in FIG. 4, a wavelength of an emissive light of the OLED according to the exemplary embodiment is mainly included within the wavelength ranges of 450 nm to 480 nm, 510 nm to 560 nm, and 600 nm to 650 nm.

Therefore, according to the Experimental Example 1 and Experimental Example 2, the filling agent absorbs most of the external light but a loss of the emissive light of the OLED passing through the filling agent is relatively small. That is, both of the Experimental Example 1 and Experimental Example 2 suppress reflection of external light while reducing or minimizing a loss of light emitted to the outside from the OLED.

However, compared to the Experimental Example 1 and Experimental Example 2, a typical filling agent that does not have a selective light absorbing function has a transmittance range of 0.9 to 1, and has a straight line-type graph for wavelength band-specific transmittance of external light through the typical filling agent. Therefore, the conventional typical filling agent cannot suppress reflection of external light.

While the present invention has been described in connection with certain exemplary embodiments, it is to be understood that the invention is not limited to the disclosed embodiments, but, on the contrary, is intended to cover various modifications and equivalent arrangements included within the spirit and scope of the appended claims, and equivalents thereof.

What is claimed is:

1. An organic light emitting diode (OLED) display comprising:
 - a display substrate assembly comprising an organic light emitting element;
 - an encapsulation substrate assembly on the display substrate assembly with a space therebetween, the encapsulation substrate assembly being sealed with the display substrate assembly; and
 - a filling agent filling the space between the display substrate assembly and the encapsulation substrate assembly,

15

wherein the filling agent is adapted to selectively absorb external light entering through the encapsulation substrate assembly and incident on the organic light emitting element as a function of wavelength in a wavelength band of the external light to control transmittance;
 wherein the filling agent is adapted to selectively absorb the external light having wavelengths in a wavelength band of 430 nm to 670 nm;
 wherein the transmittance of the external light with respect to the filling agent is higher in a wavelength band of 520 nm to 560 nm than in wavelength bands of 480 nm to 510 nm and of 580 nm to 610 nm; and
 wherein the filling agent includes a compound represented by at least one of Formula 13, Formula 15, Formula 16, Formula 17, or Formula 18:

Formula 13

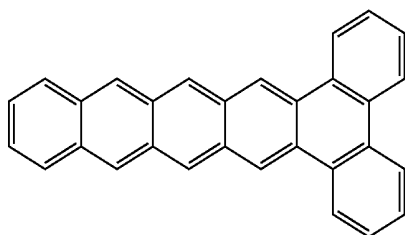

Formula 15

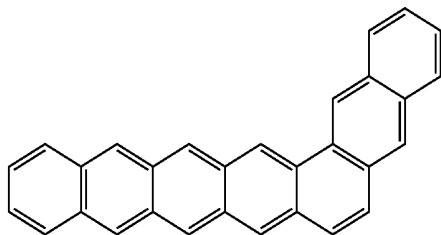

Formula 16

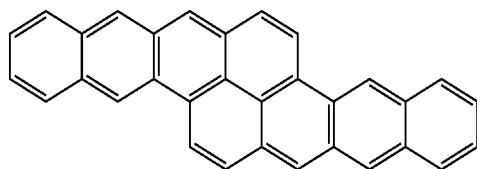

Formula 17

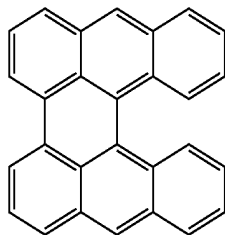

16

-continued

Formula 18

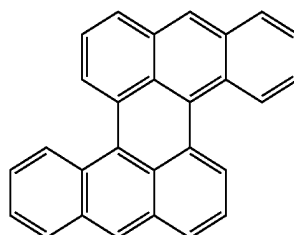

5

10

15

20

25

30

35

40

45

50

2. The OLED display of claim 1, wherein the transmittance of the external light with respect to the filling agent in a wavelength band of 460 nm to 620 nm satisfies a W shape like a quartic function having two minimums and one maximum.

3. The OLED display of claim 2, wherein the two minimums are respectively in the wavelength band of 480 nm to 510 nm and the wavelength band of 580 nm to 610 nm, and the maximum is in the wavelength band of 520 nm to 560 nm.

4. The OLED display of claim 1, wherein wavelengths of more than 80% of emissive light of the organic light emitting element are in one or more specific wavelength bands, and the one or more specific wavelength bands are not overlapped with the wavelength bands of 480 nm to 510 nm and of 580 nm to 610 nm.

5. The OLED display of claim 4, wherein the wavelengths of more than 80% of the emissive light of the organic light emitting element are in the wavelength bands of 450 nm to 480 nm, of 510 nm to 560 nm, and of 610 nm to 650 nm.

6. The OLED display of claim 1, wherein the filling agent comprises a resin containing a light absorbing material.

7. The OLED display of claim 6, wherein the resin comprises at least one of polycarbonate, polyether sulfone (PES), polymethyl methacrylate, (PMMA), polyethylene terephthalate, or triacetate cellulose.

8. The OLED display of claim 6, wherein the light absorbing material comprises at least one of carbon black, a polyene-based pigment, an azo-based pigment, an azomethine-based pigment, a diimmonium-based pigment, a phthalocyanine-based pigment, a quinine-based pigment, an indigo-based pigment, a thioindigo-based pigment, a dioxadin-based pigment, a quinacridone-based pigment, an isoindolinone-based pigment, a metal oxide, or a metal complex.

9. The OLED display of claim 8, wherein the polyene-based pigment comprises a compound represented by at least one of Formula 1 or Formula 2:

Formula 1

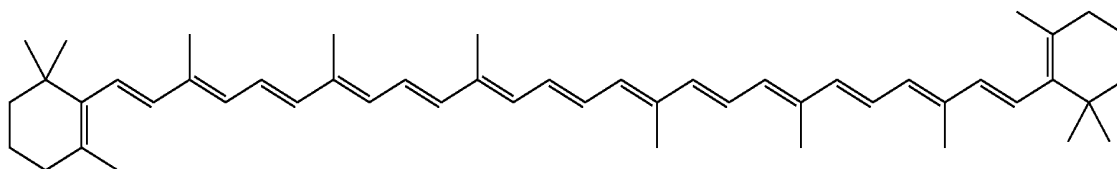

17

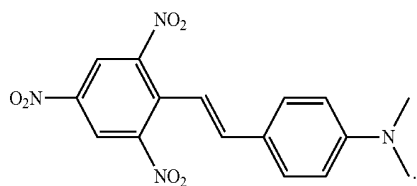

10. The OLED display of claim 8, wherein the azo-based pigment comprises a compound represented by Formula 3:

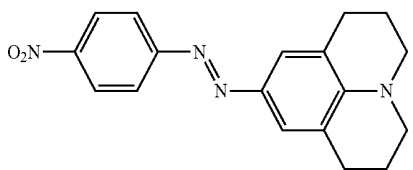

Formula 3

11. The OLED display of claim 8, wherein the quinacridone-based pigment comprises a compound represented by at least one of Formula 4 or Formula 5:

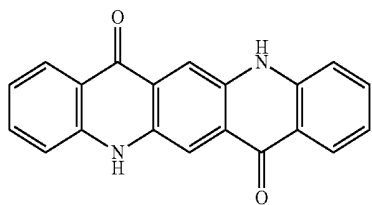

Formula 4

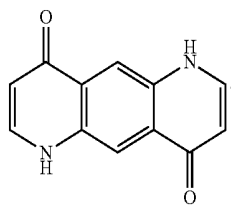

Formula 5

12. The OLED display of claim 8, wherein the quinine-based pigment comprises a compound represented by at least one of Formula 6, Formula 7, or Formula 8:

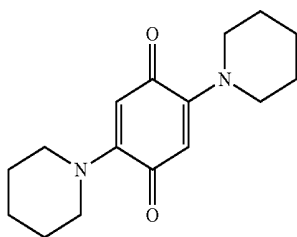

Formula 6

18

-continued

Formula 2

-continued

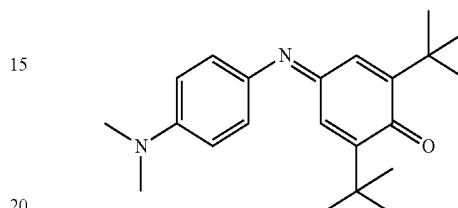

15

Formula 7

20

Formula 8

25

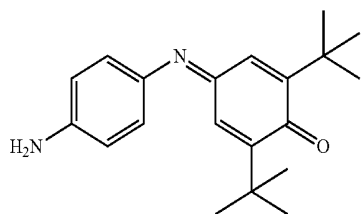

30

13. The OLED display of claim 8, wherein the indigo-based pigment comprises a compound represented by at least one of Formula 9, Formula 10, or Formula 11:

Formula 4

35

Formula 9

40

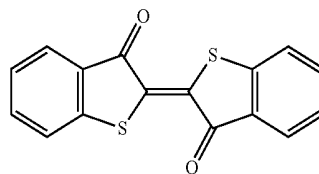

Formula 5

Formula 10

45

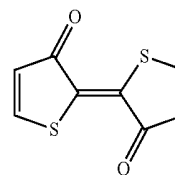

50

Formula 11

55

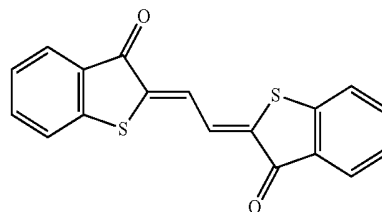

60

14. An organic light emitting diode (OLED) display comprising:

a display substrate assembly comprising an organic light emitting element;

an encapsulation substrate assembly on the display substrate assembly with a space therebetween, the encapsulation substrate assembly being sealed with the display substrate assembly; and

65

19

a filling agent filling the space between the display substrate assembly and the encapsulation substrate assembly, the filling agent being adapted to protect the organic light emitting element from impact and to selectively absorb more light in a wavelength band of external light entering through the encapsulation substrate assembly and incident on the organic light emitting element than light in a wavelength band of emissive light emitted by the organic light emitting element;

wherein the filling agent is adapted to selectively absorb the external light having wavelengths in a wavelength band of 430 nm to 670 nm;

wherein the transmittance of the external light with respect to the filling agent is higher in a wavelength band of 520 nm to 560 nm than in wavelength bands of 480 nm to 510 nm and of 580 nm to 610 nm; and

wherein the filling agent includes a compound represented by at least one of Formula 13, Formula 15, Formula 16, Formula 17, or Formula 18:

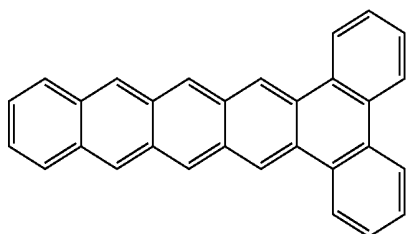

Formula 13

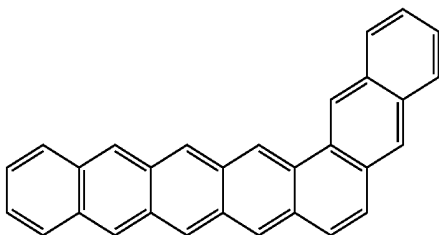

Formula 15

20

-continued

Formula 16

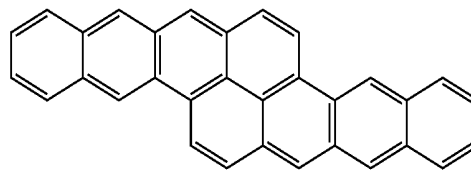

Formula 17

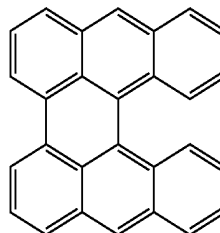

Formula 18

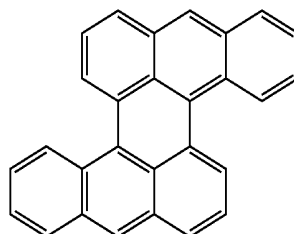

15. The OLED display of claim 14, wherein the transmittance of the external light with respect to the filling agent is higher in the wavelength bands of 450 nm to 480 nm, of 510 nm to 560 nm, and of 600 nm to 650 nm than in wavelength bands of 480 nm to 510 nm and of 580 nm to 610 nm.

* * * * *

专利名称(译)	有机发光二极管显示器		
公开(公告)号	US9112179	公开(公告)日	2015-08-18
申请号	US12/786304	申请日	2010-05-24
[标]申请(专利权)人(译)	PARK SOON RYONG JEONG HEE SEONG JUNG禹锡		
申请(专利权)人(译)	PARK SOON-RYONG JEONG HEE SEONG JUNG禹锡		
当前申请(专利权)人(译)	三星DISPLAY CO. , LTD.		
[标]发明人	PARK SOON RYONG JEONG HEE SEONG JUNG WOO SUK		
发明人	PARK, SOON-RYONG JEONG, HEE-SEONG JUNG, WOO-SUK		
IPC分类号	H01L51/52 G02B5/22		
CPC分类号	H01L51/5237 G02B5/223 H01L51/5253 H01L51/5281 H01L51/524 H05B33/04		
优先权	1020090069059 2009-07-28 KR		
其他公开文献	US20110024780A1		
外部链接	Espacenet USPTO		

摘要(译)

有机发光二极管包括显示基板组件，该显示基板组件包括有机发光元件；封装基板组件，设置在显示基板组件上，其间具有空间，并以真空密封方式与显示基板组件密封；填充剂填充显示基板组件和封装基板组件之间的空间。填充剂适于选择性地吸收通过封装基板组件进入并作为外部光波长带中的波长的函数入射在有机发光元件上的外部光以控制透射率。

